

NEC

PORTRAIT *308/824*

Multibutton Telephone Feature Handbook

P/N 82400MFH04
April 2001



Printed in U.S.A.

This manual has been developed by NEC America. It is intended for the use of its customers and service personnel, and should be read in its entirety before attempting to install or program the system. Any comments or suggestions for improving this manual would be appreciated. Forward your remarks to:

NEC America Inc., Corporate Networks Group
4 Forest Parkway
Shelton, CT 06484
cng.nec.com

Nothing contained in this manual shall be deemed to be, and this manual does not constitute, a warranty of, or representation with respect to, any of the equipment covered. This manual is subject to change without notice and NEC America has no obligation to provide any updates or corrections to this manual. Further, NEC America also reserves the right, without prior notice, to make changes in equipment design or components as it deems appropriate. No representation is made that this manual is complete or accurate in all respects and NEC America shall not be liable for any errors or omissions. In no event shall NEC America be liable for any incidental or consequential damages in connection with the use of this manual. This document contains proprietary information that is protected by copyright. All rights are reserved. No part of this document may be photocopied or reproduced without prior written consent of NEC America.

©2001 by NEC America. All Rights Reserved.
Printed in U.S.A.

Year 2000 Compliance

The Portrait 308/824 systems are unaffected by the date change to the year 2000. The entry of the year in the date is used to display Leap year (02/29) dates. The year does not display on display telephones. A two-digit year is used for the SMDR output.

Table of Contents

Using Your Telephone	1
Calling a Co-Worker	2
Outside Calls	2
Handling And Rerouting Your Calls	3
When Your Call Can't Go Through	3
Placing Calls Quickly	4
When You Work In Groups	5
If You Need Privacy	5
Have a Telephone Meeting	6
Streamlining Your Telephone's Operation	6
Personalizing Your Telephone	7
Account Codes	9
Alarm Clock	9
Background Music	11
Call Forwarding	11
Executive Call Forwarding	12
Call Parking	14
Call Timer	14
Call Waiting (Camp On)	15
Caller ID	17
Caller ID Table	17
Caller ID Temporary Memory	18
Callback	22
Conference	23
Confirmation Tone	24
Direct Station Selection Console, DSS (Portrait 824)	25
Direct Station Selection, Extension	26
Directed Call Pickup	28
Directory Dialing	29
Do Not Disturb	30
Door Box	31
Executive Override	32
Extension Hunting	33
Flash	33
Handsfree (Speakerphone)	34
Headset Compatibility	36
Hold	36
Hotline - Dual Handsfree Hotline	38
Intercom	39
Last Number Redial	40
Meet-Me Conference	41
Message Waiting	43

Table of Contents

Microphone Mute.....	45
Name/Message Storing.....	46
Night Answer (Off-Hours Ringing)	49
Off-Hook Signaling	50
Outside Calls, Answering.....	52
Outside Calls, Placing.....	52
Line Queuing	53
Automatic Line Access	54
Converting from Pulse to Tone Dialing	54
Are You Behind a PBX?	55
You May Have a Private Line	55
If You Hear a Warning Tone	56
Did Your Call Go Through?	56
Need to Block Outgoing Calls From Your Phone? . . .	56
Paging	58
Internal Page	58
External Page	58
Programmable Keys	59
Repeat Dial.....	62
Room Monitor	62
Save	63
Selectable Display Messaging	65
Broadcast Message At A Later Time	65
Do Not Disturb / General Message	66
Message Waiting	66
Camp-On	66
Reverse Message	66
Speed Dial.....	74
System Speed Dial	74
Personal Speed Dial	74
Step Calling.....	76
Tandem Trunking.....	76
Time And Date Setting	78
Transfer	79
Voice Mail.....	80
Volume Control	83
Charts.....	85

Using Your Telephone

Using Your Telephone

Your telephone's **Alphanumeric Display** helps you use features and tells you about your calls. For example, you can see the name of a co-worker who calls you. (You may also be able to change the time and date on your phone if it's not correct. Turn to page 78 for more.)

Press a **One-Touch Key** for one-button contact with co-workers and outside callers or when using certain features. To learn how to program your One-Touch Keys, go to page 59.

Handsfree lets you place and answer calls by pressing  instead of using the handset. The **Microphone** picks up your voice for Handsfree calls.

The system may restrict you from using some of the features in this handbook. Check with your Communications Manager to see which features are available. Also, if your system does not use the standard numbering plan shown on page 85, feature access codes may be different than described.

Using Your Telephone

Calling a Co-Worker

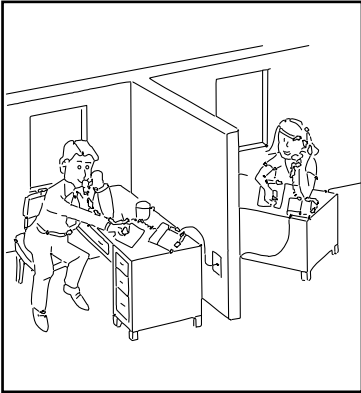

You can dial a co-worker on the **Intercom** (page 39), or use **Paging** (page 58) if you don't know where they are.

Visitors at your entrance door can call you on the Intercom using a **Door Box** (page 31).

Outside Calls



You can **Answer Outside Calls** that ring your phone or flash your line keys (page 52). **Night Service** (page 49) may change the way these same calls ring your phone.

To **Place Outside Calls** (page 52), use your line keys or dial codes. You may have to enter **Account Codes** (page 9) before your call goes through. Once your call goes through, the **Call Timer** (page 14) shows you how long you're on the

phone. You may be able to use **Flash** (page 33) to place another call without losing your line.

Using Your Telephone

Handling And Rerouting Your Calls



Use **Hold** (page 36) to have your call wait at your phone. Or, if your system is a Portrait 824, **Park** it in orbit for a co-worker (page 14).

Have a call for a co-worker? **Transfer** it to them (page 79).

When you leave your desk, think about **Call Forwarding** your calls to someone else (page 11). Or, if you want your callers to know where you are, set a **Selectable**

Display Message at your phone (page 65).

When Your Call Can't Go Through



Don't just hang up when your call can't get through to a co-worker! Use **Call Waiting** (page 15) to wait without hanging up. Send your co-worker **Off Hook Signaling** (page 50) to let them know you're waiting. If you don't have time to wait, leave a **Callback** request (page 22).

In a hurry? Think about leaving your co-worker a **Message Waiting** (page 43).

Using Your Telephone

There's no need to keep redialing your outside call if it's busy or unanswered - use **Repeat Dial** instead (page 62). And when your system's lines are busy, **Line Queuing** (page 53) lets you wait for a free one.

With **Selectable Display Messages**, send a message to your busy co-worker's display phone (page 65). They can reply with a **Reverse Message** (page 66).

Placing Calls Quickly

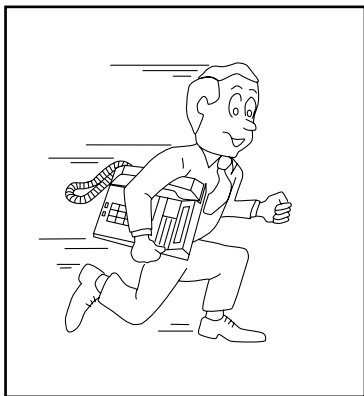

Store numbers that you call often in **Speed Dial** bins (page 74). You can easily dial the stored number with just a few key presses. To quickly retry the number you just dialed, try **Last Number Redial** (page 40). If you'll need to redial the number later on, let **Save** (page 63) retain it for you.

Using Your Telephone

When You Work In Groups

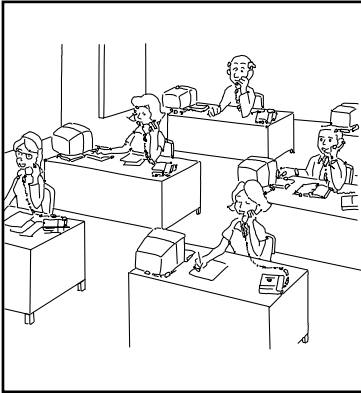

If you and your co-workers handle each other's calls, you might want to have **Extension Hunt Groups** (page 33). Someone calling your group's number goes through to the first available extension. If there is no answer at that extension, a co-worker can try the next extension in line using **Step Calling** (page 76). To answer a call already ringing a co-worker's phone, use **Directed Call Pickup** (page 28).

If You Need Privacy

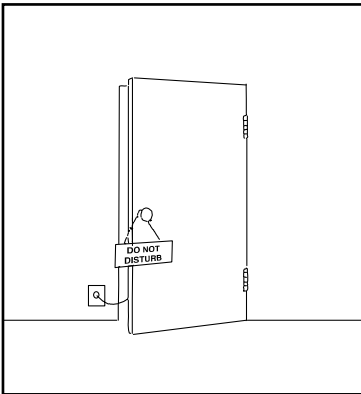

When you're busy in your office and don't want to be interrupted, use **Do Not Disturb** (page 30).

Before talking to someone at your desk while you're on a handsfree call, try **Microphone Mute** (page 45). Your caller cannot hear your voice until you cancel Microphone Mute.

Using Your Telephone

Have a Telephone Meeting

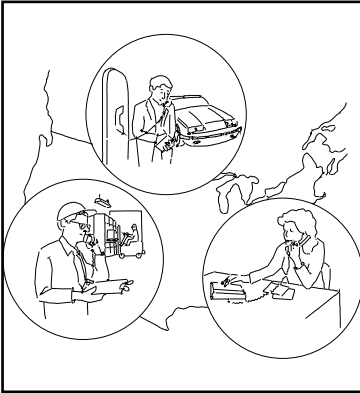

Conference (page 23) allows you to quickly set up a telephone meeting.

Use **Meet Me Conference** (page 41) to set up a meeting which lets others join if they choose.

Optionally, you can also use **Meet Me Page** to set up a meeting on a page zone.

To join two outside callers together and leave them to talk privately, use **Tandem Trunking** (page 76).

Streamlining Your Telephone's Operation

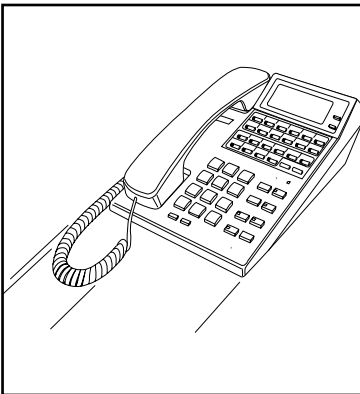

Your telephone provides you with options that can dramatically streamline the way you handle calls. For example, you can use **One-Touch Keys** for one-button access to co-workers, outside calls, **Speed Dial** numbers and certain feature codes.

Are you a secretary for two people? Use **Dual Handsfree Hotline** (page 38). This allows one

extension to simultaneously call two other extensions. The 'secretary'

Using Your Telephone

extension can make a voice announced Intercom call over the speaker of both 'executive' extensions. The users at the executive extensions can reply Handsfree and all three parties can talk.

Tired of always reaching for the handset or cradling it under your chin while you type? Install a headset and enable **Headset Operation** (page 36).

Personalizing Your Telephone



If your system is a Portrait 824, when you need to cover up noise in your office that might be distracting to your work, turn on **Background Music** (page 11).

Don't forget about that important meeting - set an **Alarm** (page 9) to remind you.

Let the co-workers you call know who's on the line. Go to **Name Storing** (page 46) and assign a name to your extension.

To have your phone beep every time you press a dial pad key, enable the **Dial Pad Confirmation Tone** (page 24).

Using Your Telephone

Your Multibutton Phone

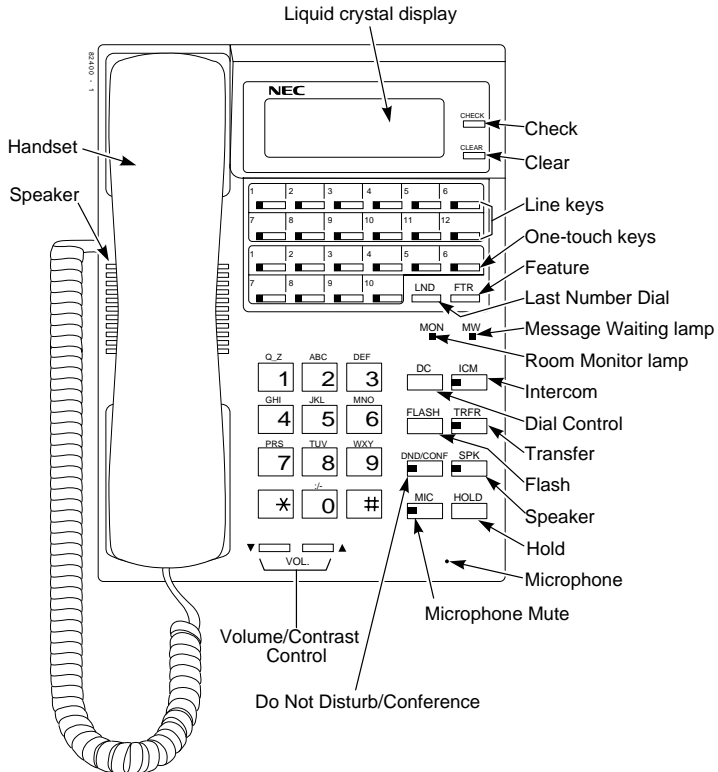

Account Codes

Account Codes

Account Codes are codes you enter that help keep track of outside calls. There are two types of Account Codes: Optional and Forced. With optional codes, the Account Codes you enter are solely for categorizing your calls. For example, if you work in an accounting firm that must bill back customers for time on the phone, Optional Account Codes are for you. Forced Account Codes also let you categorize calls, but you must enter one before placing outgoing calls. If you don't enter the code, you can't place the call. This ensures that calls don't go out untracked. Check with your Communications Manager to find out if your system uses Account Codes - and which codes you should enter. Account Codes can be from 1-8 digits long, using 0-9 and #.

To enter an Account code for an outside call:









1. Seize an idle CO line
 - Listen for: Dial tone
 - If you're on an active outside call already, skip this step.
2. Dial .
3. Dial Account Code.
4. Dial .
5. Dial telephone number.

Alarm Clock







You can use your display phone like an alarm clock to remind you of appointments and important meetings. Your phone has two alarms that can each be programmed for a specific time. The alarms sounds every day at the set time unless they are cancelled. This feature can be programmed as a One-Touch key in the Programmable Keys feature.

Alarm Clock

To set an alarm at a display keypad:

1. Press .
2. Press   .
- *If programmed as a One-Touch key, press the One-Touch key instead.*
3. Dial  to set the first alarm or dial  to set the second alarm.
4. Dial time in terms of a 24-hour clock.
 - *For example, dial 1545 for 3:45 PM.*
5. Dial .
6. To hang up, press .

To check an alarm setting:









1. Press .
2. Press   .
3. Dial  to check the first alarm or dial  to check the second alarm.
4. Press .

To stop the alarm tone:

1. Press .

Background Music

To cancel an alarm:

1. Press .
2. Press   .
3. Dial  to cancel the first alarm or dial  to cancel the second alarm.
4. Dial .
5. To hang up, press .

Background Music (Portrait 824 only)

Background Music (BGM) sends music from an FM receiver, tape deck or CD player your company provides to the speaker in your telephone. This helps give you a pleasant working environment. The Background Music plays whenever your phone is idle.

To turn BGM on or off while an extension is idle:

1. Do not lift handset.
2. Press .

Call Forwarding

Use Call Forwarding to redirect your calls to another extension. With Call Forwarding, you're sure your calls are covered when you are away from your work area. There are four types of Call Forwarding:

- **0 = Call Forward, Immediate**
All calls forwarded immediately to the destination.
- **1 = Call Forward When Busy**
Forwarded only when the extension is busy.

Call Forwarding

- **2 = Call Forward When Unanswered**

Forwarded only if the call is unanswered.

- **3 = Call Forward When Busy / Unanswered**



Forwarded only when the extension is busy or unanswered.

Call Forwarding will reroute all calls, including calls transferred from another extension. You must enable Call Forwarding from your phone.

Executive Call Forwarding

This feature allows two extensions to be specially paired for the purpose of forwarding calls. The extension designated as the 'executive' can forward its incoming calls to the extension designated as the 'secretary'. If, for example, the executive sets the phone to Do Not Disturb, the executive's calls are forwarded to the secretary's extension. The secretary's extension can reach the executive's extension even when Executive Call Forward is activated.

To activate Call Forwarding from a keyset:

1. Press .
2. Press .
3. Dial destination extension number.
4. Dial option code:
 - **0 = Call Forward, Immediate**
-All calls forwarded immediately to the destination.
 - **1 = Call Forward When Busy**
-Forwarded only when the extension is busy.
 - **2 = Call Forward When Unanswered**
-Forwarded only if the call is unanswered.

Call Forwarding

To activate Call Forwarding from a keyset (cont.):

- **3 = Call Forward When Busy / Unanswered**

- Forwarded only when the extension is busy or unanswered.
- Listen for: one short beep as confirmation of procedure or one long beep indicating call cannot be forwarded to that extension.
- Note: If no code is entered, all calls forward immediately to the destination extension.

5. Press .

To cancel Call Forwarding from a keyset (must be done from originating extension):

1. Press .

2. Press  twice.

3. Press .

To activate Executive Call Forward:

1. Press  at the executive's extension.

To cancel Executive Call Forward:

1. Press  twice at the executive's extension.

Call Parking

Call Parking (Portait 824 Only)

Call Parking allows you to place an outside call in a waiting state (called a Park orbit) so that any other keyset extension within the same Park group may pick it up. After parking the call, you can Page the person receiving the call and hang up. The paged party just presses the Park key from any extension within the same Park group to pick up the call. This is also useful when transferring a call to a keyset that does not have a line appearance on their phone for that line.

To place a call on Park:

1. While on an outside call, press Park key.

To answer a call on Park (within the same Park group as the extension that placed the call in Park):

1.  LIFT
2. Press Park key.

Call Timer

You can time your outside calls on your telephone display. You'll find Call Timer indispensable if you must keep track of your time on the phone.







There are two ways to activate the timer. The first type of timer is set up in the system programming. This timer automatically starts when you place an outgoing call. The display changes to a stopwatch at the beginning of the call and stops timing when you hang up. The display shows the duration of the call for approximately eight seconds and then changes to display the date and time.

The second type offers more flexibility. You can press a programmed One-Touch key at any time before placing or answering a call, or

Caller Waiting (Camp On)

while on a call. You can also time Intercom calls or use the idle telephone as a stopwatch.

To activate the manual Call Timer:

1. Press    to start timing.
2. Press    again to stop timing.
3. Press  to return to the date and time.

Call Waiting (Camp On)

After you call a busy extension, use Call Waiting to wait in line (i.e., Camp On) without hanging up. When you Camp On, the system signals the busy user indicating that you are waiting. Your call goes through when the busy extension becomes free.

Call Waiting also helps when you are on the phone because it lets you know when additional calls are trying to get through. Call Waiting lets your callers wait in line without being forgotten.

To send a Call Waiting tone to a busy extension:

1. Place Intercom call.
 - Listen for: Busy signal
2. Dial .
3. Do not hang up.
 - Wait for the call to go through. Ringing is heard as soon as the extension becomes free.

Caller ID

Caller ID

Caller ID allows a display keyset to show an incoming caller's telephone number and/or name with the time and date on the phone's display. The caller's information can be checked before answering an incoming call. The information received by the system depends upon the capabilities of your local telco.

There are two types of Caller ID message formats currently available: Single Message Format and Multiple Message Format. With Single Message Format, the telco sends only the caller's phone number (DN). The DN is either 7 or 10 digits long. In Multiple Message Format, the telco sends the DN and the caller's name. The DN for this format is also 7 or 10 digits long, and the name provided consists of up to 15 characters. The data remains stored for the duration of the call.

Information Received:	Display Shows:	Display After Pressing CHECK:
Name/Number	number name	number telco time/date
Number	number telco time	number telco time/date
Name	NO NUMBER INFO name	NO NUMBER INFO telco time/date
Call from Non-ID	line number	line number
Service Area	NO CALLER INFO	NO CALLER INFO
No Caller ID	NO NUMBER INFO	NO NUMBER INFO
Information	telco time/date	telco time/date

Caller ID Table

Caller ID information (name and number) can be stored in the system's Caller ID Table (up to 100 bins). Keyset users can also make outgoing calls using the Caller ID Table. The Caller ID Table and the Temporary Memory bins can only hold a maximum of 10 digits. Therefore, a long distance number can not be stored in a bin.

Temporary Memory

When a call is abandoned or the Caller ID table is full, the caller's information will be stored in the Temporary Memory (up to 24 Caller ID names and numbers). If the Temporary Memory is full, the oldest Caller ID information will automatically be deleted and the new information will be stored in its place.

The Temporary Memory can be used for the following:

- Placing an outgoing call using the stored Caller ID information.
- Transferring stored Caller ID information from the Temporary Memory to the Caller ID Table.

The Caller ID Table and the Temporary Memory bins can only hold a maximum of 10 digits. Therefore, a long distance number can not be stored in a bin.

To view Caller ID information with Pre-Answer Display:

1. Do not lift the handset.
2. Press **LINE**.
3. Press **CHECK** to display further information (if available).
 - *If Single Step Access is enabled, the user must press the FLASH key then the line key.*

To view Caller ID information with Post-Answer Display:

1. Answer call as normal (Caller ID information is displayed).
2. Press **CHECK** to display further information (if available).

Caller ID

To store Caller ID information in the table:

1. Answer call.

2. Press and dial .

- If a confirmation tone (one short beep) is heard, the information was successfully stored in the next empty memory bin in the Caller ID Table. If an error tone (three short beeps) is heard:
 - the system does not allow the extension to edit the table (Program 61 [C.]).
 - the call does not have Caller ID information available
 - another extension is storing information simultaneously
 - the Caller ID Table is full

To store new information or edit existing information:

1. Do not lift handset.

2. Press .

3. Dial for a specific bin number then enter bin number (001-100)

OR for the next available bin number.

4. Press .

5. Enter telephone number.







6. Press .

7. Enter caller's name (see the Name/Message Storing feature).





8. Press .

9. Press .

Deleting a bin's entry:

1. Press  key.
2. Dial  .
3. Dial bin number (001-100).
4. Press .
5. Press .
6. Press .
7. Press .

To make an outgoing call using a bin number:

1. Press .
2. Dial  .
3. Dial bin number (001-100).
4. Press .

- *Dialing out from a stored number may not work with all central offices. The number stored in the bin may have to be edited (e.g. With 203-926-5400, the "203" may have to be removed in order to dial the number properly).*

Caller ID

To search the Caller ID Table for a stored number:

1. Press .
 2. Dial .
 3. Dial the digits of the phone number to be searched (up to 10 digits max.).
 4. Press .
- The first name and number is displayed.*
- Press (forward) or (backwards) to scroll.
5. To call the displayed number, press

.

OR

To edit the information, press + follow the editing instructions explained previously.

OR



To delete the information: Press .

+ .

To search the Caller ID Table for a stored name:

1. Press .
2. Dial .
3. Starting with the last name, enter the letters of the name (up to 15 letters max.) to be searched.
4. Press (the first name and number is displayed).

To search the Caller ID Table for a stored name (cont.):

- If needed, scroll by pressing  (forward) or  (backwards).



5. To call the displayed number, press

.

OR



To edit the information, press  + follow the editing instructions explained previously.

OR



To delete the information: Press   + .

To place an outgoing call from the Temporary Memory:

1. Press .

2. Dial  .

3. Scroll to find the number desired.



-  scrolls forward,  scrolls backward.

4. Press  when number displayed.

- If the extension is not allowed to edit the Temporary Memory, an error tone will be heard after dialing '95'.





To clear all stored information in the Temporary Memory:

1. Press .

2. Dial  .

Callback

To transfer information from the Temporary Memory to the Caller ID Table:

1. Press .
2. Dial  .
3. Press .
4. Press .



- *The information will be stored in the next available bin.*

Callback

When you call a busy extension, you can leave a Callback request for a return call. You do not have to repeatedly call the busy extension back, hoping to find it idle. When you leave a Callback, the system handles your request as follows:

- When the busy extension becomes idle, the system rings you.
- After you answer the Callback ring, the system then rings the formerly busy extension. (If that extension doesn't answer, the system cancels the Callback.)
- As soon as the other extension answers, the system sets up an Intercom call between you and them.

To place a Callback:

1. Place Intercom call.
 - *Listen for: Busy tone*
2. Dial .
3. 

Conference

To answer the
Callback signal:

The signal is a quick double ring.

1. 
• Extension is called.

To cancel Callback:

1. Lift handset to cancel Callback before receiving the Callback signal.

2. 

Conference

Conference lets you add additional inside and outside callers to your conversation. With Conference, you can set up a multiple-party telephone meeting without leaving the office. The system allows up to one outside and five inside parties to be added to the conversation. If Multi-Line Conference is enabled, a second outside call can be added to the conversation. In addition to Conference, there are other ways to have a telephone meeting. See Meet Me Conference and Meet Me Paging (page 41), and Tandem Trunking (page 76).

Method 1

To establish a
conference call:

1. Establish the first call.

2. Press  .

3. Press  and dial extension number or establish second outside call.

- For Intercom calls, the party must answer using the handset.

4. Press  .

- Conference is established. To add more inside parties, repeat steps 2-4.

Confirmation Tone

Method 2

To establish a Conference call:

1. Establish an outside call.

2. Press .

3. Press  and call the other extension by paging and announce the CO line key number.

- *The called party must press the CO line key to join.*

4. Press .

To join a Conference when invited:

1. 

2. Press .

Confirmation Tone

The Confirmation Tone feature allows a tone to be emitted from the built-in speaker on the keyset each time you press a line, feature or dial pad key. The tone confirms the key was fully pressed.

To activate the Confirmation Tone:

Do not lift handset.

1. Dial .

To cancel Confirmation Tone:

Do not lift handset.

1. Dial .

- *Listen for: Final Confirmation Tone is heard.*

Direct Station Selection Console, DSS

Direct Station Selection Console, DSS (Portrait 824 only)

If you do a lot of call processing (like an operator or dispatcher), you may have a Direct Station Selection (DSS) Console. The DSS Console gives you a Busy Lamp Field (BLF) and one-button access to extensions and certain system features. Use the DSS Console to help you:

- **Call Extensions and Door Boxes**
- **Transfer outside calls**
- **Make Internal or External Pages**

Your DSS Console may also have keys stored with Programmable Feature Key operations. This gives your DSS Console many of the features available on One-Touch and function keys. Check with your Communications Manager to see if your console has these functions.

To call an extension from your DSS Console:



1. 
2. Press one of the DSS keys.
 - *If your call voice-announces, you can make it ring by dialing 1. If you don't have Handsfree, you must lift the handset to speak.*

Extension BLF	
<i>If DSS key is . . .</i>	<i>Extension is . . .</i>
On	Busy on a call
Off	Idle
Flashing fast	In DND

Automatic Hold of CO line:

1. While on a CO call, press a DSS key.

Direct Station Selection, Extension

Unannounced Transfer:

1. While on a CO call, press a DSS key.
 - *The CO call is put on Hold and a call is placed to the desired extension.*

2. Press .

- *Called extension rings.*

Announced Transfer:

1. While on a CO call, press one of the DSS keys.

- *CO call is put on hold and a call is placed to the desired extension.*

2. Make announcement.

3. Press .

- *CO call is transferred.*
- *If the called party doesn't want the call, press the flashing line key to retrieve it.*

To make a Page using your DSS Console:

1. Press programmed Page key.

2. Make announcement.

- *If you don't have Handsfree, lift the handset to make your announcement.*

3. .



Direct Station Selection, Extension

Direct Station Selection (DSS) provides you with one-button access to other extensions in the system. Each of the ten One-Touch keys on your telephone can be programmed to call a particular extension. You can also program the One-Touch keys to access any Page Zone or Door Box.

If you have a display keyset, a Busy Lamp Field (BLF) indication is shown for any One-Touch keys you have programmed. This shows you if your co-worker is on a call, in Do Not Disturb, or idle.

Direct Station Selection, Extension

To program a One-Touch key for DSS:

1.  LIFT
2. Press .
3. Dial .
4. Press One-Touch key.
5. Dial extension number.

OR

To program a Page Zone, dial 80-87 (86 and 87 can only be assigned as DSS keys on the Portrait 824 system).

OR



To program a Door Box, dial 88 or 89.

6.  HANG UP

To use a DSS key:

1.  LIFT
 - *If Single Step Access is programmed and the phone is equipped with a speakerphone, this step can be skipped.*
2. Press One-Touch key set as DSS key.

To display the number programmed under a DSS/One-Touch key:



1. Do not lift handset.
2. Press .
3. Press .
4. Press One-Touch key.
 - *Key number displays, then stored number.*
5. Press  to return to normal display.

Directed Call Pickup



Directed Call Pickup

Use Directed Call Pickup when you need to answer a call ringing another extension without leaving your phone. This lets you easily cover a co-worker's calls when they have to be away from their desk.





To intercept Intercom, Unannounced Transfer and DISA calls to a co-worker's phone:

1. 
 - Do not press .
 2. Dial extension number of ringing phone.
OR
Dial .
- If more than one extension is ringing, this code answers the calls in the following order: Intercom calls, Unannounced Transfer and Incoming calls on a DISA line.*

To use Directed Call Pickup to answer a Door Box call:

1. 
2. Dial .

To use Directed Call Pickup to answer an outside incoming call:

1. 
2. Press   .







Directory Dialing

Directory Dialing







If you have a display phone, Directory Dialing lets you call a Speed Dial or Intercom number by choosing the name associated with the number. You do not have to dial the number - you just select the displayed name instead. This feature can be programmed as a One-Touch key in the Programmable Keys feature.

To store a name for each Speed Dial number and station, refer to the Name/Message Storing feature (page 46).

To use Directory Dial to place a Speed Dial call:

1. Press  .
2. Enter the first letter of the name by Name/Message Storing feature.
3. Find the name using  or .
-  = *Advance scroll*
 = *Backward scroll*
4. Press .
- *Call dials out.*

To use Directory Dial to place an Intercom call:

1. Press  .
2. Enter the first letter of the name by Name/Message Storing feature.
3. Find the name using  or .
-  = *Advance scroll*
 = *Backward scroll*
4. Press .
- *Call dials out.*

Do Not Disturb

Do Not Disturb

Do Not Disturb (DND) blocks Page announcements, ringing and incoming voice announcements to your extension. DND permits you to work undisturbed at your desk without interruptions from your phone. When you activate DND, incoming calls still flash your line keys. While in DND, you may still use your phone in the normal manner for placing and processing calls.

There are four levels of DND which can be programmed into the system for each extension:

- Level 0 = No DND capability
- Level 1 = Blocks CO audible, allows Intercom calls
- Level 2 = Blocks CO audible and Intercom calls
- Level 3 = Blocks CO audible and Intercom calls or just CO audible

A co-worker calling an extension in DND hears a fast busy signal.

To activate DND:

1. ***If programmed for level 1:*** Press  once to allow Intercom calls, but block CO calls.

-  *flashes.*

If programmed for level 2: Press  once to block all Intercom and CO calls.



-  *lights steadily.*

If programmed for level 3: Press  once to block CO audible and Intercom calls.



-  *lights steadily.*

OR

To activate DND (cont.):

1. Press  twice to block just CO audible.  flashes.
 - *To activate DND while on a call, press FTR then DND/CONF.*

To cancel DND:

1. Do not lift handset.
2. Press  once or twice (whichever makes  extinguish).
 - *To cancel DND while on a call, press FTR then DND/CONF.*

Door Box

Your system may have Door Boxes. A Door Box is a self-contained Intercom unit typically used to monitor an entrance door. A visitor at the door can press the Door Box call button (like a door bell). The Door Box then sends chime tones to all extensions programmed to receive chimes. If you receive Door Box chimes, you can just lift the handset to answer them. You can then talk to the visitor at the door.



Door Boxes come in handy at delivery entrances. Your company doesn't have to have someone at the door to monitor the entrance. You can just answer the Door Box instead. If the door has an electric strike, you can even use your telephone to release the door.

To answer the chime tones (from your phone):

1. 
 - *Connection established.*







Executive Override

To answer the chime tones by Directed Call Pickup:

1.  LIFT
2. Dial .

- *Connection established.*

To call a Door Box:

1.  LIFT
2. Press , then   for box 1
or   for box 2.



To unlock / lock the door after contacting the Door Box:

1. Press  to activate the relay.
 - *The relay remains closed for 5 seconds (This could be longer or for as long as the FLASH key is held down, depending on programming).*

Executive Override

Executive Override lets you override the system's privacy feature - you can break into an outside call at another extension, including a call on a Private Line. The intrusion may or may not be preceded by a warning tone, depending on programming. The warning tone comes over the speaker of both extensions. You must have outgoing line access for the line you wish to override.

To use Executive Override to break into a call:

1.  LIFT
2. Press steadily lit .

- *This breaks into the telephone conversation on that line. The extension being overridden may or may not hear a beep.*

Extension Hunting

Extension Hunting

Extension Hunting routes internal and DISA calls to a predefined group of hunt group member extensions. A call will ring the first available extension in the hunt group. Extension Hunting is helpful, for example, for a group of co-workers that share responsibility for answering calls. Each new call rings the first available extension in the hunt group. If you receive no answer, use Step Calling (page 76).

To call a hunt group number:



1.



2. Press

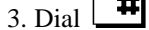

3. Dial

4. Dial hunt group number (0-4).

- *First available extension is called. If there is no answer, the user can dial # again to call the next idle extension (see Step Calling, page 76).*

Flash

Flash allows a keyset user to access certain features of the telephone company or PBX to which your phone system is connected. This lets you take full advantage of whatever features the connected telephone company or PBX offers. Flash accesses these features by momentarily interrupting the loop current on your outside line. This is much like briefly pressing and then releasing the hookswitch on your telephone at home.

To flash the outside line you are on:



1. Press

Handsfree (Speakerphone)

Handsfree (Speakerphone)

When it's inconvenient to hold the handset, you can use the speaker and microphone in your telephone and talk Handsfree instead. Handsfree is great when you don't have a free hand for the phone. (For example, you may want to enter data at a computer terminal while talking to a customer on the phone.)

There are three types of Handsfree operations:

Handsfree



You can place and answer calls by pressing SPK instead of using the handset. You must have a Speakerphone to have Handsfree. Check with your Communications Manager.

Automatic Handsfree

You can press a line or line appearance key without first lifting the handset or pressing SPK. Your Communications Manager may have enabled this option for you.

Monitor

You can place a call without lifting the handset, but you must lift the handset to speak. You always have this option with a multi-button phone - regardless of the type of phone you have or how your system is set up.



Where you see  or 'Lift handset', you can optionally use  for almost any feature instruction, unless otherwise specified.  must be pressed again to hang up.

Handsfree (Speakerphone)

To place a call
Handsfree:

1. Press .
 - If Single Step Access is programmed, this step can be skipped.
2. Obtain outside or Intercom dial tone in the usual way.
 - Listen for: Dial tone
3. Dial number.
 - Speak toward phone when call is established.



To answer an outside
call using Handsfree:

1. Press .
 - If Ringing Line Preference is programmed, this step answers the call.
2. Press flashing .
3. Speak toward phone.

To hang up a
Handsfree call:

1. Press .

To change a handset
call into a Handsfree
call:

1. Press .
2. 
HANG UP

To change a
Handsfree call into a
handset call:

1. 
LIFT

Headset Compatibility





Headset Compatibility

To get even more freedom and convenience than with Handsfree, purchase a Headset and connect it to your telephone. In addition to having your hands free for other work, you'll have privacy on a call that is not available with Handsfree.

To install the headset:

1. Make sure your phone is idle and programmed for headset operation.
2. Unplug the handset.
 - *Leave the handset in the handset cradle.*
3. Plug in the headset.

To operate the headset:

1. Press  whenever you see the instruction, 'Lift handset' or  .
OR
Press  whenever you see the instruction, 'Hang up' or  .
 - *The SPK key functions as a Release key.*

Hold

Don't place your handset down on the desk when you need your caller to wait, use Hold instead. Hold places your call in a temporary waiting state until you can get back to it. While the call waits, you can process calls or use other features. And don't worry if you forget about the call and leave it on Hold too long - it will recall back to you.

Your telephone system provides three types of Hold (see the following information). Your Communications Manager can tell you which types you can use.

Hold (also known as System Hold)

For normal calls . . .

When you place an outside call on Hold, it flashes your line key and the line keys on your co-workers' phones as well. Either you or another co-worker can pick up the call on Hold. However, Intercom calls on Hold do not indicate at any other extensions and no other system features can be accessed without disconnecting the call.

Exclusive Hold

For high priority calls . . .

After you place an outside call on Exclusive Hold, it flashes your line key but looks busy to your co-workers. Only you can pick up the call from Hold.

Automatic Hold

For easier call processing . . .

With a call on the line, without pressing Hold first, you can initiate another feature. The system places the call on Hold automatically when you press ICM or DND/CONF (If you press DND/CONF, do not hang up the phone or the call will be disconnected as this is not a true system Hold).

You can program a feature key on your display phone for Recall Line Display Mode. When a Hold Recall tone is heard, the display will show the line and station number of the recalling line (refer to Programmable Keys, page 59).

To place an Intercom or outside call on Hold:

1. Press 

2.  HANG UP

- *If you place an Intercom call on Hold, do not hang up the handset or the call will be terminated.*

To place an outside call on Exclusive Hold:

1. Press  twice.





2.  HANG UP

Hotline-Dual Handsfree Hotline

To retrieve an outside call on Hold:

1.  LIFT
2. Press flashing .





To retrieve an outside call on Hold at another extension:

1.  LIFT
 2. Press flashing .
- OR**
- Press .
- Dial   and the extension number that placed the call on Hold.
- *Call is connected.*

To retrieve an Intercom call on Hold:

1. Press .

To activate/cancel Recall Line Display:

1. Press .
2. Press .
3. Press .
4. Press .

Hotline - Dual Handsfree Hotline



Dual Handsfree Hotline allows you to simultaneously call two other extensions. A 'secretary' extension can make a voice announced

Intercom

Intercom call over the speaker of two 'executive' extensions. The users at the executive extensions can reply Handsfree (i.e., by just speaking toward the phone) and you can all talk.

The simultaneous call goes through only if both executive extensions are idle and an executive extension has not forwarded Intercom calls. When an executive replies by lifting the handset, the other executive is disconnected. The secretary can make a ringing Intercom call to both executives; however, an executive must lift the handset to reply, which disconnects the other executive.

To place a Dual Handsfree Hotline call:

1.  at secretary extension.
2. Press .
3. Dial either executive's extension number.
 - *Both extensions are called. If ringing is heard, the secretary can dial 1 to convert the call into a voice announced call. If busy tone is heard, the secretary can still contact the other executive by repeating step 2-3 using the other executive's extension number.*

Intercom



Call a co-worker over the Intercom. You are not restricted from placing an Intercom call to any other extension. Intercom calls can ring or voice-announce at the called extension.

Each extension user can:

- Force Intercom calls they place to ring the called extension, regardless of other programming
- If allowed system-wide, enable/disable voice-announce for their Intercom calls

Last Number Redial

To place an Intercom call:

1.  LIFT
2. Press .

- *Listen for: Dial tone*
3. Dial extension number.
 - *To convert a ringing call into a voice announced call or vice versa, dial '1'.*

To answer an Intercom call if you hear two beeps:

- Listen for: Two beeps*
1. Speak toward phone

To answer an Intercom call that rings your phone:



Listen for: ICM ring

1.  LIFT

Last Number Redial

Instead of dialing a busy or unanswered outside call again, quickly redial it with Last Number Redial. Last Number Redial stores the last outside call you placed in memory so you can easily recall it. The stored number can be up to 18 digits long, using 0-9, # or *. You can also quickly redial your last call using Repeat Redial (page 62) and Save (page 63).

To use Last Number Redial:

1.  LIFT
2. Press .
3. Press .





Meet-Me Conference

Meet-Me Conference

Use Meet-Me Conference to have a telephone meeting with up to five other co-worker's. After you announce the Meet-Me Conference over the Paging, a co-worker joins the meeting by dialing the Meet-Me Conference code.



Need to talk to only one other co-worker and don't know where they are? Meet-Me Paging allows you to set up a private meeting on a Page zone with one other co-worker. While you meet on the zone, no one else can hear your conversation, join in or make an announcement using that zone.

To set up a Meet-Me Conference:



-  1. LIFT
2. Press  .
3. Dial code.
 - 80 for All Call
 - 81-84 for zones
 - 85 for All Call, external zones only
 - 86-87 for external zones (Portrait 824 system only)
4. Page desired parties. Announce that parties should press  .
5. Press  .
6. Do not hang up.
 - Listen for: Conversation with Conference members.

Meet-Me Conference





To reply to a Meet-Me Conference:

1.  (Do not press ).
2. Press .
 - Listen for: Conversation with Conference members.

To set up a Meet-Me Page:

1. .
2. Press .
 - Listen for: Dial tone
3. Dial code.
 - 80 for All Call
 - 81-84 for zones
 - 85 for All Call, external zones only
 - 86-87 for external zones (Portrait 824 system only)
4. Page person, announce code (Portrait 308 = 80-85, Portrait 824 = 80-87).
5. Dial . Do not hang up.
 - Listen for: Conversation with Conference member.

To join a Meet-Me Page:

1.  (Do not press ).
2. Dial announced code (Portrait 308 = 80-85, Portrait 824 = 80-87) or if calling party is in the same zone, dial 
.
- Listen for: Conversation with Conference member.

Message Waiting

Message Waiting

Don't keep recalling a busy or unanswered co-worker. Leave them a Message Waiting request for a return call instead. The request is a quick flashing MW LED at the multibutton extension you called and a double wink LED on your phone. When your co-worker answers the Message Waiting, they automatically call your extension. And if someone leaves you a Message Waiting, you'll know you didn't miss their call.

In addition, Message Waiting lets you:

- Cancel all the messages you left at other extensions
- Cancel all messages co-workers left at your extension
- View and selectively answer messages left at your extension (display keyset only)

You can leave messages at any number of extensions. Also, any number of extension users can leave a Message Waiting at your extension.

To leave a Message Waiting (at an extension that is busy or does not answer):

-Listen for: Busy, Ringing or two beeps.

1. Dial .

- MW flashes intermittently as confirmation.

2. 
HANG UP





To cancel all Message Waiting indications you left and that were left for you (display phones only):

1. Press .





2. Press .

Message Waiting





To cancel all Message Waiting indications you left:

1.  LIFT
2. Dial   .
3.  HANG UP

To cancel an individual Message Waiting from the originating phone:

1.  LIFT
2. Dial , extension number, .
3.  HANG UP





To cancel an individual Message Waiting from originating or received phone (display phone only):

1.  LIFT
 2. Press  .
 - *The first message appears. Use '*' to advance and use '#' to go backward.*
 3. Press  to cancel a message.
- OR**
- Press  to return to the phone to an idle condition.





Microphone Mute

To display the extension number that left a Message Waiting (display phone only):

Do not lift handset.

1. Press .
2. Dial .
 - *Extension number displays.*
3. To display the next extension number that left a Message Waiting indication, dial  again.
4. Press  to return to normal display.

To answer a Message Waiting:

1.  LIFT
2. Press .
3. Dial .
 - *The extension is called.*
4. If you receive no answer, you can call the next extension that left a Message Waiting indication by dialing .

Microphone Mute

Turn your telephone's Handsfree microphone off when you don't want your caller to hear your voice. When you turn your Handsfree microphone off, it stays off until you turn it back on. (If you place an outside call on Hold to initiate another CO or ICM call, the microphone is reactivated for all the calls. When you hang up, though, the microphone will be muted for any ICM calls until you deactivate the feature.)

Name/Message Storing

To activate
Microphone Mute:

1. Press .

- *The MIC LED lights steady. You can do this while on a call or when your phone is idle.*

To deactivate
Microphone Mute:

1. Press .

- *The MIC LED goes out.*

Name/Message Storing

You can create identification names for each outside line, extension and Speed Dial number in the system. This helps you and your co-workers when you place and answer calls.

When you call a co-worker that has a display telephone, they see your name instead of your extension number. Your co-worker knows who's calling without having to look up your extension number. When you answer an incoming call, the display on your phone identifies what line you're answering - such as LOCAL, SERVICE, SALES, etc. When you use Directory Dial, you can scroll through the names assigned to Speed Dial numbers or co-worker's to help you in placing your calls. The names can be up to eight characters long, consisting of letters, numbers, symbols and spaces. The storing operation is possible only from station #10.

To enter a name:

1. Numbers: dial 0-9 on the dial pad for the desired numbers.
2. Letters and Symbols: Use the One-Touch keys (1-3) with dial pad (0-9):
 - *To enter a letter/symbol:*
 - *1) Press the first, second, or third One-Touch key for the letter's position on the dial pad button (e.g., Press*

Name/Message Storing

To enter a name
(cont.):

the first One-Touch key and dial pad key '2' to get the letter 'A')

- 2) Press the dial pad key showing the letter or symbol you desire.

For phones with `Q-Z' on digit 1:

One-Touch key 4 = space

One-Touch key 5 = delete a character

One-Touch key 6 = delete all characters

For phones with no letters on digit 1:

One-Touch key 5 = space

One-Touch key 6 = delete a character

One-Touch key 7 = delete all characters

Digit 1 = _ : /

- To shift the cursor left or right, use '*' to shift to the left while '#' shifts to the right.

To program a trunk
name:

1. Press  twice.

2. Press  to be programmed.

3. Dial .

4. Input the letters of the name.

- See 'To enter a name' above.

5. Press next  to program and dial





.

OR





Press   to finish.

Name/Message Storing

To store a station name:

1. Press  twice.
 2. Press .
 3. Dial extension number to be stored.
 4. Dial .
 5. Input the letters of the name to be stored.
 - See 'To enter a name' above.
 6. Press .
 7. Dial next extension number to store.
- OR**
- Press  to finish.

To store a Speed Dial name:

1. Press  twice.
 2. Press .
 3. Dial the Speed Dial number to be named (2-digit Speed Dial: 00-99 or 3-digit Speed Dial: 000-199).
 4. Press .
 5. Input the letters of the name to be stored.
 - See 'To enter a name' above.
 6. Press .
 7. Enter the next Speed Dial number.
- OR**
- Press  to finish.

Night Answer (Off-Hours Ringing)

Night Answer (Off-Hours Ringing)

You may be able to activate Night Answer for your system. Used after normal working hours, Night Answer redirects your system's incoming calls to where they should ring at night. For example, when most of your co-workers have left for home, your system may redirect calls to the security desk.

There are two types of Night Answer modes available:

- The operator (station #10) enables Night Answer for all lines in the system. Night audible assignments go into effect at each extension in the system. Day audible assignments are ignored. This Night Answer mode is activated by station #10.
- Tenant Groups can be programmed to enable Night Answer for their lines only. Any extension within the Tenant Group can activate Night Answer.

To activate/deactivate
Night Answer:

1. Press .

2. Press .

3. Dial .

- *TRFR lights if activated or extinguishes if deactivated.*

4. Press .

To cancel Night
Answer:

1. Press .

2. Press .

3. Dial .

- *TRFR goes out.*

4. Press .

Off-Hook Signaling

Off-Hook Signaling

Trying to get in touch with a co-worker who is busy on a call? Use Off-Hook Signaling to let your co-worker know you're trying to get through.

There are two types of Off-Hook Signaling: CO Off-Hook Signaling and Intercom Off-Hook Signaling. With **CO Off-Hook Signaling**, an incoming CO call will send muted ringing to your phone if you are on a handset call or one short burst of tones if on a Handsfree Intercom call.



Intercom Off-Hook Signaling lets you send a signal to a busy extension, then wait for a reply. The signal is one short burst of tones, which comes over the speaker of the busy extension. In addition, the ICM key at the busy extension flashes. The busy extension user can choose not to reply to the signal if it is inconvenient to do so.

Signals can be sent manually or automatically. If your system requires you to manually send the signal, you simply press a key on the dial pad. The automatic type sends a signal any time you call a busy extension. Intercom Off-Hook Signaling cannot be sent to a busy extension when it is using Handsfree Answerback.

You can use other options when you are trying to get through. Use Call Waiting (page 15) to wait in line without hanging up. Or, you can leave a Callback request for a return call (page 22). If you want, send your co-worker a Message Waiting indication (page 43). You can also send a Selectable Display Message to your busy co-worker, if they have a display phone, while they stay on their initial call. They can then send you a reverse message to your display phone asking you to call back later, take a message, etc. (page 65).

Off-Hook Signaling

To answer CO Off-Hook Signaling:

1. Press  to put an outside call in progress on Hold or hang up the call in progress.
 - *You must hang up an Intercom call since no other feature can be used without disconnecting the Intercom call.*
2. Press the flashing .

To manually send Intercom Off-Hook Signaling:

1. Place an Intercom call.
 - *Listen for: Busy tone*
2. Dial .
3. Wait for a reply.
 - *To send more tones, dial 1 again.*

To use automatic Intercom Off-Hook Signaling:

1. Place an Intercom call.
 - *When the called extension is busy, one short burst of tones is heard instead of a busy tone.*
2. Wait for a reply.
 - *To manually send more tones, dial 1.*

To answer an Intercom Off-Hook Signaling:



1. Press flashing .
- *This answers the waiting call and puts an outside call in progress on Hold. This step will, however, terminate an Intercom call in progress; Intercom calls cannot be put on Hold to use other features.*

Outside Calls, Answering





Outside Calls, Answering

Answering incoming calls can be as simple as pressing a line key or dialing an access code. There are many types of outside calls that you can answer from your phone. Ask your Communications Manager about the different types of calls you are expected to answer. You may have line and loop keys on your phone. A line key is dedicated to a particular outside line. When you press the line key to answer a call, you always get the same line. A loop key works just like a line key, except that it is for any line in a preset line group. When you press a loop key to answer a call, you get whichever line in the group happens to be ringing.

To answer a trunk call:

1.  LIFT
2. If not connected to the call, press the flashing .

To answer an outside call by Dial Pickup:

1.  LIFT
 2. Press .
 3. Dial  .
- *Call is connected.*

Outside Calls, Placing

Your phone offers you several ways to place outside calls. You can:

- **Press a line key** for one-button access to a specific line
- **Press a loop key** for one-button access to the first available line in a line group
- **Dial a code** to select a specific line
- **Dial a code** to select the first available line in a line group



Outside Calls, Placing

The method you use depends on how your system and your phone are set up. For example, if your office is set up like a 'key system', you and your co-workers will have line keys for the same outside lines. Your Communications Manager can tell you which method you should use for placing outside calls.



To place a call using a line or loop key:

1. Press an available line or loop key.
 - *You may have to press SPK or lift the handset before pressing the line or loop key.*
2. Dial number.

To place a call using Line Groups when line appears under a CO key:

1.  LIFT
2. Press  .
 - *Listen for: Dial tone*
3. Dial telephone number.

To place a call using Line Groups when line does not appear under a CO key:



1.  LIFT
2. Press   .
3. Dial two-digit line number.
 - *Listen for: Dial tone*
4. Dial telephone number.

Line Queuing

When all outgoing lines in a particular group are busy, Line Queuing puts you on a 'waiting list' for an available line in the group. As soon as a line becomes free, your phone rings and a line key flashes. When signaled, you must answer within 20 seconds or the line rings the next person on the 'waiting list'.

Outside Calls, Placing



To use Line Queuing:

1.  LIFT
2. Press .
3. Dial Queue Group number (1-6).
 - *If you hear busy tone, the extension can not use Line Queuing for that group.*
4.  HANG UP

Automatic Line Access

Automatic Line Access lets you access an outgoing line without pressing a line key or dialing a two-digit line number. A single-digit code automatically accesses an outgoing outside line.

To access the first available outgoing line using Automatic Line Access:

1. Press .
 2. Dial .
- *A line is seized and dial tone comes over the speaker.*

To access the first available line in a Queue Group using Automatic Line Access:

1. Press .
2. Dial Queue Group number (1-6).
 - *A line is seized and dial tone comes over the speaker.*

Converting from Pulse to Tone Dialing

If your company is in a Dial Pulse area, you may need to change the dialing mode of your phone to tone (DTMF) after you place your initial call. This allows you to use dial-up services like electronic banking or a client's Voice Mail.

Outside Calls, Placing

- To select DTMF:**
1. Dial phone number (pulse mode).
 2. Dial .
 3. Dial number (tone mode).

Are You Behind a PBX?

Your telephone system may be connected to a Private Branch Exchange (PBX) rather than to the telephone company's lines. This means that when you get dial tone on an outside line, you are really getting dial tone from the PBX. This may affect the way you place outside calls. For example:

- After you press a line key, you may have to dial an additional access code (e.g. 9) before you can dial your outside number.
- The PBX may restrict you from placing certain types of calls.
- You may be able to Transfer and Conference your calls to other systems connected to the same PBX.

Ask your Communication's Manager if you are behind a PBX.

- To place a call if the system is behind a PBX:**
1. Access an outside trunk.
 2. Dial the PBX trunk access code before the telephone number.

You May Have a Private Line

A Private Line is simply a line on your phone that nobody else in the system can use. Only you can place and answer calls on your Private Line. Your Communications Manager can tell you if you have a Private Line.

- To place a call on your Private Line:**
1.  LIFT
 2. Press Private Line key.
 - *Listen for: Dial tone*
 3. Dial number.

Outside Calls, Placing

If You Hear a Warning Tone





While on an outside call, you may hear occasional beeps through your speaker or handset. These tones remind you that you have been on the call a long time.

Did Your Call Go Through?

If you dial certain calls and you find that they do not go through, ask your Communications Manager the following questions:

- Do I need to enter Account Codes (page 9) for outside calls?
- Is my telephone Toll Restricted? If it is, what numbers am I prevented from dialing?

To temporarily override Toll Restriction while placing a call at a co-worker's desk:

1.  LIFT
2. Press an idle .
3. Press .
4. Press .
5. Dial security code.
6. Dial phone number.





Need to Block Outgoing Calls From Your Phone?

If you're going to be away from your desk, you can temporarily program your phone to block outgoing calls. If this option is enabled for you, just enter a four-digit personal code. If this 4-digit personal code is forgotten, it can be cleared by the system administrator (extension #10) by entering a special password.





When Dial Block is activated, anyone trying to place a CO call will hear an error tone and the line will drop.

Outside Calls, Placing

To set Dial Block:







1. Press .
2. Dial  .
3. Dial 4 digit personal code.
 - *You can dial any number as a personal code.*
4. Dial .
 - *Listen for: Confirmation tone when feature activated.*
 - OR**
 - Error tone when feature is not activated.*
5. Press .

To release Dial Block:

1. Press .
2. Dial   and enter the 4-digit code that was used when feature was activated.
3. Dial .
 - *Listen for: Confirmation tone when feature deactivated OR Error tone when feature is not deactivated.*
4. Press  to hang up.

Paging

To release Dial Block if personal code is forgotten (from station #10 only):

1. Press .
2. Dial  .
3. Dial password (73738 = RESET)
 - *Note: This is not the system password. This is a special password used for this feature only.*
4. Press .
5. Enter the station number to be cleared.
6. Press .
- *To enter additional stations, press '#'.*
7. Press  to exit.

Paging

Internal Page

Need to locate a co-worker or make an announcement? Use Internal Paging. Your system can have All Call Internal Paging and up to four zones of Internal Zone Paging. When you make an All Call Paging announcement, your voice broadcasts to all idle extensions. When you make a Zone Paging announcement, your voice broadcasts to all the idle extensions in the zone you called.



External Page

If you have your own external speaker system installed, you may be able to use it for External Paging. This is particularly helpful in large or noisy areas where the Internal Paging speakers in the telephones are not loud enough. Your system can have either one external Page Zone (Portrait 308) or All Call External Paging and two external Page Zones (Portrait 824). The system can also be programmed to allow

Programmable Keys

incoming calls, Background Music (BGM) (Portrait 824 only) from an external source, and/or alarm signals to broadcast over the external page zone(s).

To make a Page:

1.  LIFT
2. Press  .
 - Listen for: Dial tone
3. Dial code.
 - 80 for All Call (This can be programmed to page all internal and external zones. Check with your Communications Manager for current programming.)
 - 81 for internal zone 1
 - 82 for internal zone 2
 - 83 for internal zone 3
 - 84 for internal zone 4
 - 85 for all external zones
 - 86 for external zone 1 (Portrait 824 only)
 - 87 for external zone 2 (Portrait 824 only)
4. Make announcement.
5.  HANG UP

Programmable Keys

Customize your phone by storing features or outside lines under your Programmable Feature Keys. For example, instead of pressing SPK + TRFR + # + SPK to enable Night Answer, just press your Night Answer feature key instead. The 12-line phones have 22 programmable keys while the 6-line phones have 16. This allows you to store the

Programmable Keys







features you use most often under the One-Touch, CO or DSS keys. The chart below shows the available features and their corresponding feature numbers.

Note that outside lines can only be stored in the top row and the first two keys on the left in the second row (keys 1-8).









Feature		Feature	
#	Feature	#	Feature
00	Undefine a feature key	14	Loop Key (CO key only)
01	Alarm Clock	15	Store Caller ID info. in table
02	Call Timer	16	Edit Caller ID Table
03	Day/Night Mode	17	Add Caller ID data to table
04	Monitor	18	Search Caller ID Table by Number
05	Monitored	19	Search Caller ID Table by Name
06	Recall Line Display	20	Check/Edit Temporary Memory
07	Repeat Dial Key	21	Clear Temporary Memory
08	Repeat Dial (Hurry up)	22	Record (CO key only)
09	Directory Dial (CO)		
10	Directory Dial (ICM)		
11	Park/Hold Retrieve		
12	Walking Class of Service Access		
13	Call Forward Mode (DISA)		

Programmable Keys



To store a feature under a One-Touch or CO key:

1. Press  .
2. Press   .
3. Press a desired One-Touch key or  .
4. Dial feature number (01-22).
5. Dial  .
6. Press  .

To delete a feature stored on a One-Touch or CO key:

1. Press  .
2. Press   .
3. Press a One-Touch key or  with the stored feature you wish to delete.
4. Dial   to delete the stored feature.
5. Dial  .
6. Press  .

To check a feature stored under a One-Touch or CO key:



1. Press  .
2. Press a One-Touch key or  where the feature is stored.
 - *The description of the set feature displays.*

Repeat Dial



Repeat Dial

Trying to get in touch with a customer and their phone is always busy or unanswered? Don't keep redialing it manually - have Repeat Dial do it for you. Repeat Dial will retry your call automatically until the called party answers or the feature is cancelled. The number of times the system retries a call is programmable. Your Communications Manager can tell you how the system is programmed. While this feature is active, a reminder tone will be heard every 30 seconds from the phone's built-in speaker to remind you that the Repeat Dial feature is active.



To use Repeat Dial:

1. Place an outside call.
 - *Listen for: Busy tone or ring-no-answer.*
2. Press  and dial .
OR
Press a programmed one-touch key.
 - *The Portrait 308 system has one-touch key 9 set for Repeat Redial at default.*
3. .
 - *The system periodically redials the call.*

To cancel Repeat Dial:

1.  then .

To use Hurry-Up operation (redial call immediately):

1. Press .
2. Dial .







Room Monitor

Use Room Monitor when you want to listen to the sounds in another work area. For example, Room Monitor could let you listen to the

sounds in the warehouse when it's left unattended. You just set up a Room Monitor with a phone in the warehouse area.

You must activate Room Monitor at your phone and at the phone you want to monitor. You can only monitor one phone at a time, but any number of phones can monitor the same extension. In addition, Room Monitor is for listening only (i.e., you cannot talk to the monitored extension).

To activate or cancel Room Monitor:

1.  at the extension to be monitored.
2. Press .
3. Press  .
 - *MON flashes fast while Room Monitor is activated.*
4.  .
5. From the monitoring phone, do not lift handset.
6. Press .
7. Press  .
 - *MON flashes intermittently while Room Monitor is activated.*

Save

While on an outside call, you can save the number you just dialed and easily dial it later on. This lets you quickly redial a busy or unanswered number without manually dialing any digits. Your system remembers your saved number until you save a new number in its place.

Save

You can also quickly redial your last call using Last Number Redial (page 40) and Repeat Redial (page 62).

To Save an outside number any time after placing a call:

-Do not hang up.

1. Press  twice.

OR

Press One-Touch key.



- *Save can retain a number up to 18 digits long, using 0-9, # or *.*

2. 
HANG UP

To dial a Saved outside number:

1. 
LIFT

2. Press .

3. Press  .

OR

Press One-Touch key.

- *The stored number dials out.*

To store the Save feature as a One-Touch key:

Initial system programming has One-Touch key #10 on all keyset phones programmed for Save.

1. Press .

2. Press  .

3. Press a One-Touch key.

4. Press  .

5. Press .

Selectable Display Messaging

Selectable Display Messaging

Activate a Selectable Display message when you leave your desk. A co-worker calling your extension will see the message you activated on their telephone's display. For example, when you leave for vacation, select the message, 'ON VACATION'. Your callers will know why you don't answer. Other than displaying the message, the system puts the calls through normally. The system administrator could program up to 50 Selectable Display Messages which would be available to you. In addition, you can program two Personal Display Messages (One-Touch keys #1 and #2).

You can add additional information to messages 00, 01, 02, 12 and 13. For example, the administrator could program message 00 with, 'Call'. You could select this message and add the numbers where you can be reached (e.g., 926-5400). Callers to your extension would see, 'Call 926-5400'. The original message plus the appended digits cannot exceed 16 digits.

In addition, you can also send messages when using the following features:

- Broadcast Message at a Later Time
- Do Not Disturb / General Message
- Message Waiting
- Camp-On
- Reverse Message

Broadcast Message at a Later Time

A message can be set to indicate a message on all display phones in a hunt group at a programmed time. The message will display on the phones for one minute with an alarm tone. Broadcast Messages cannot be sent to non-display or single line phones. An error signal will be heard when programming for these types of phones. This also applies to hunt groups that contain no display phones.

Selectable Display Messaging

Do Not Disturb / General Message

When Do Not Disturb is activated or if you're just away from your desk, you can program a message for all display phones calling your extension.

Message Waiting

When an extension user Intercoms a display phone and receives a busy signal or no answer, you can leave a Message Waiting indication with a selected message.

Camp-On

When you place an Intercom call to a busy display phone, the Camp-On feature can be activated and a message can be sent to the busy extension. Intercom Off-Hook Signaling must be enabled at the called extension.

Reverse Message

If you have received an Off-Hook Signal, you can send a message to the calling extension if it is inconvenient to reply to the signal. For example, you could select message 49 'CALL BACK LATER'.



Preset Messages		
No.	Message	
00	Call	*
01	Call After ____:____	*
02	Call Ext.	*
03	Call Me ASAP	
04	Do Not Disturb	
05	In Conference	
06	In Meeting	

Selectable Display Messaging



Preset Messages (cont.)	
No.	Message
07	Left for the Day
08	On Break
09	On Vacation
10	Out of Office
11	Out to Lunch
12	Out Until ___:___ *
13	Out Until ___/___ *
14	Page Me
15	Please See Me
16	See Me ASAP
17	With a Client
18	With a Patient
19	With a Visitor
47	Take Message
48	Please Hold
49	Call Back Later

* Message 00, 01, 02, 12 and 13 can have digits added to them.

To select a Display Message:

1. Press .
2. Enter the message number desired.
3. Press .

To cancel a Display Message:

1. Press .
2. Press .

Selectable Display Messaging

To store text in One-Touch key #1 and #2:

1. Press CHECK FTR.
2. Press One-Touch key #1 or #2.
3. Dial *.
4. Enter your own message by using the Name/Message Storing feature (page 46).
5. Press CHECK.
6. Dial *.
7. Press next One-Touch key to be entered.
OR
Press CLEAR to finish.

To store system message (station #10 only):

1. Press CHECK and FTR.
2. Dial message number (00-49).
3. Dial *.
4. Edit message by using the Name/Message Storing feature (page 46).
5. Press CHECK.
6. Dial message number to store.
7. Dial *.
8. Dial message number for next storing.
OR
Press CLEAR to finish.

Selectable Disply Messaging

Broadcast Message

To set up a Broadcast Message at Later Time message:

1. Press CHECK and FTR.
2. Dial message number (00-49), dial *.
- OR**
Press One-Touch key #1 or #2 for a personal message, then dial *.
3. Edit message if required.
4. Press ICM.
5. Dial an extension number or hunt group number (00-04).
6. Press ICM to set more extensions if required.
 - *This step is only available when extension number is dialed at step 5.*
7. Dial *.
8. Enter the time to send message.
 - *Time must be entered as four digits and as a 24 hour clock (e.g., 3:00 p.m. entered as 1500).*
9. Dial *.

To cancel Broadcast Message:

1. Press CHECK.
2. Press TRFR.



Selectable Display Messaging

To stop the alarm tone and clear the display:





1. Press .

Do Not Disturb Message / General Message

To set a DND/General message using preset messages:

1. Press .
 2. Dial message number (00-49), dial .
- OR**
- Press One-Touch key #1 or #2 for personal message, then dial .
- *DND/CONF flashes intermittently as confirmation.*

To set a personal DND message:

1. Press  and .
 2. Use Name/Message Storing feature to enter a message (page 46).
 3. Press  and .
- *DND/CONF flashes intermittently as confirmation.*

To cancel the DND message:

1. Press .

Selectable Display Messaging

To activate or cancel previously programmed DND / General message:

1. Press  and .

 - When DND message is activated, DND/CONF flashes intermittently.

Message Waiting Message

To leave a Text message with a Message Waiting:

1. Place an Intercom call.
 - Listen for: *Busy or no answer*
2. Dial .

 - MW flashes intermittently as confirmation.
 - Display shows 'LEAVE MESSAGE?'

3. To leave no Text Message, hang up.

OR

Dial  to leave Text Message.



4. Dial message number (00-49), dial .

OR

Press One-Touch key #1 or #2 for a personal message, then dial .

OR

Press , enter a message by using the Name Storing feature (page 46), then









press  again and dial .

- A text message is left for the called display phone. Your co-worker must use the procedure below to read it.







5.  HANG UP

Selectable Display Messaging

To cancel message from extension that left the message:

1. Press    (Portrait 308)
OR   (Portrait 824).
 - *First message appears on the display.*
2. Use  to advance and use  to backup.
3. Press  to cancel message.
OR
Press  to return to idle condition.







To view or delete a message at extension that received the message:

1. Press  .
 - *First message appears on the display.*
2. Use  to advance and use  to backup.
3. Press  to call back.
OR
Press  to delete message.
OR
Press  to return to idle condition.

Selectable Display Messaging

Camp-On Message

To set a Camp-On message:

1. Place an Intercom call.
 - *Listen for: Busy tone*
 2. Activate Off-Hook Signaling by pressing .
 3. Press .
 4. Dial message number (00-49), dial .
OR
Press One-Touch key #1 or #2 for personal message, then dial .
OR
Press , edit a message using the Name Storing feature, then press  again and dial .
- *Confirmation tone is heard when message is sent.*

Reverse Message

To send a Reverse Message when an Off-Hook Signal is received:

1. Press .
2. Dial message number (1-3).
 - 1 = System common message #47 (default message=TAKE MESSAGE)
 - 2 = System common message #48 (default message=PLEASE HOLD)
 - 3 = System common message #49 (default message=CALL BACK LATER)

Speed Dial

Speed Dial

Speed Dial gives you quick access to numbers you call frequently. This saves time, for example, when calling a client with whom you deal often. Instead of dialing a long telephone number, you just use Speed Dial.





There are two types of Speed Dial: *Personal Speed Dial* and *System Speed Dial*. Personal Speed Dial numbers are programmed individually by each user. System Speed Dial numbers are only programmed at station 10, but are available to every system extension.

Each phone has up to 10 Personal Speed Dial numbers reserved for your own use. You program the numbers to which you'd like to have quick access. System Speed Dial numbers have a maximum of 200 Speed Dial numbers (00[0]-199). If you have a 2-digit extension plan with access to only 100 Speed Dial numbers, your numbers range from 00-99. If you have a 3-digit extension plan with access to only 100 Speed Dial numbers, your numbers range from 100-199.

Each Speed Dial number can accommodate up to 18 digits, using any combination of digits 0-9, pauses (TRFR key), flashes (FLASH key), and stops (DND/CONF key). When a Stop is inserted, dialing will be stopped at that position and can be continued by dialing '**'.





System Speed Dial

To program a Speed Dial Number (station #10 only):

1. Press .
2. Press  and .
3. Dial Speed Dial Number (00[0]-199).
4. Dial phone number to be stored.
5. Repeat steps 2 through 4 for additional numbers.
6. Press  to exit.





Speed Dial

To call a System Speed Dial number:







1. Press  or press .
2. Press an idle .
3. Press .
4. Dial Speed Dial number (00[0]-199).

Personal Speed Dial

To store a Personal Speed Dial number:

1. Press .
2. Press  and .
3. Press a One-Touch key.
4. Dial phone number to be stored.
5. Repeat steps 2 through 4 to program additional numbers.
6. Press  to exit.

To clear a Speed Dial number:

1. Press .
2. Press  and .
3. Enter the System Speed Dial Number or press the One-Touch key.
4. Press  .
5. Press .

Step Calling

To place an outside call:

1. Seize a **LINE**.
2. Press a One-Touch key which stores the selected number.

Step Calling

When you make an Intercom call and receive a busy signal or no answer, Step Calling lets you call the other extensions, in ascending order, by just dialing '#'. For example, if extension 12 is busy, Step Calling tries extension 13. If there is no answer at extension 13, Step Calling tries extension 14, and so on. Step Calling is cancelled if it reaches an extension that is not installed.

To initiate a Step Call:

1. Place an Intercom call.
 - *Listen for: Busy tone or no answer.*
2. Dial **#**.
 - *Next extension is automatically called.*
To call the next extension, dial '#' again.

Tandem Trunking

Tandem Trunking lets you set up a Conference with two outside callers and then drop out of the call - leaving the callers talking in an Unsupervised Conference. Once you drop out you are not part of the conversation. The Unsupervised Conference continues until you reenter the conversation and hang up the call or either party terminates the call. You can rejoin the Conference and end it whenever you choose.

If you are a dispatcher for outside service people, for example, you can use Tandem Trunking to put two of your service people in touch:

- Answer a call from one service person
- Place a call to the second service person
- Set up the line-to-line Conference
- Drop out of the call

Tandem Trunking

Note: Central Office Loop Supervision must be provided to prevent lines from remaining conferenced/busy when the parties hang up.

To establish an Unsupervised Conference:

Note: When both outside parties finish the call, unsupervised conference must be manually terminated by the telephone which set up the call.

1. Establish first outside call.

2. Press  .

- *The call is put on Hold.*

3. Establish second outside call.

4. Press  .

- *Three-party Conference is established.*

5. Press  .

- *Both outside parties are put on Hold.*

6.  HANG UP

- *Unsupervised Conference is established.*

To later join an Unsupervised Conference:

1.  LIFT

2. Press either  of the Conference call.

To later join an Unsupervised Conference:

1. Establish a three-party Conference.

2.  HANG UP









- *Both outside lines become idle.*

Time and Date Setting

Time and Date Setting

You see the Time and Date on your telephone's display when it is idle and while using some functions of the phone. The Time and Date are programmed at the station connected to port 10 (usually extension 10). Although entered in 24-hour format, the system time always displays in 12-hour format (AM/PM).

To set the system time and date (the entire procedure must be performed):



1. Press   .
 2. Dial the four digits for the year.
 - For example, 1998.
 3. Dial .
 4. Dial two digits (01-12) for the month.
 - January = 01, February = 02, etc.
 5. Dial two digits (01-31) for the date.
 6. Dial .
 7. Dial a single digit (0-6) for the day.
 - Sunday = 0, Monday = 1, etc.
 8. Dial .
 9. Dial four digits for the time (24-hour clock).
 - For example, dial 1305 for 1:05 p.m.
 10. Dial  .
- The display shows the new date and time.

Transfer

Transfer lets you quickly send the call you are on to a co-worker. You can Transfer any outside call. If a call you transfer is not answered, it automatically recalls to your extension.

You may Transfer a call Screened or Unscreened. With Screened Transfer, you announce the call to the destination user before hanging up. With Unscreened Transfer, you send the call through without an announcement.

To Transfer your call:

1. Do not hang up.
2. Press  and dial extension number.
3. Announce the call (optional).
4. Press .
5.  HANG UP

To return to your outside call (if the called party doesn't want your Transfer):

1. Press flashing .

To receive a transferred call ringing your phone:

1.  LIFT
2. Press flashing  if necessary.
 - *Call is connected.*

Voice Mail

To receive a transferred call (if you are talking on the handset):

1. Stay on the handset.
 - *The Transfer goes through when the calling party presses TRFR.*

Voice Mail







☞ This feature requires an optional NVM-Series Voice Mail system.

Tired and frustrated by missed calls, inaccurately written messages and telephone tag? End these hassles with Integrated Voice Mail. Ask your Communications Manager if you have this type of Voice Mail system installed. Integrated Voice Mail enhances your phone by giving you:

Call Forwarding to Voice Mail	To have your incoming calls automatically go to your mailbox, forward your calls to Voice Mail. Your callers can leave a message instead of calling back later. You can have forwarding for all calls immediately, for unanswered calls, or for both unanswered calls and when your extension is busy.
Leaving a Message	When you call a co-worker and their phone is unanswered, busy or in Do Not Disturb, you can easily leave a message in their mailbox. You don't have to call back later.
Transferring to Voice Mail	Transfer a call to your own or a co-worker's mailbox. After the Transfer goes through, your caller can leave a message in the mailbox.
Conversation Record	While on a call, press your Record key to record the conversation in your mailbox. Voice Mail stores the conversation like any other voice message. You can then save, edit or delete the recorded conversation.

Calling Your Mailbox

To program a voice mail key:

1.  LIFT
2. Press  .
3. Press  .
4. Press the one-touch key to be programmed.
5. Dial   .
6.  HANG UP

To call your mailbox:

1. Press the Voice Mail key.
2. (Optional) After answer, dial security code.
 - Ask your Communications Manager for your security code.

Leaving a Message

To leave a message in the mailbox of an unanswered extension:



The extension you call can be busy, in DND or unanswered.

1.  .
 - The Voice Mail system will prompt you to leave a message.



Voice Mail

Forwarding Calls to Your Mailbox

To activate Call Forwarding:





1.  LIFT
2. .
3. Dial station number of the voice mail.
4. Dial Call Forwarding condition:
 - 0 = All Calls
 - 1 = Not answered
 - 2 = Busy
 - 3 = Busy or not answered
5.  HANG UP

To cancel Call Forwarding:

1. .
2.  twice.
3. .

Transferring Calls to a Mailbox







To Transfer your active call to a mailbox:

1. .
2. Dial station number.
 - *This number can be your mailbox number or a co-worker's mailbox number.*
3. Press .
4. Press .
5.  HANG UP







Volume Control

Recording Your Call

To assign a Recording key:

1.  LIFT
2.  .
3. Dial  4 and press a line key.
4. Dial  2  .
5. Press  .
6.  HANG UP

To record your active call in your mailbox:

1. Press the programmed Record key.
OR
 1. If it's an Intercom call, press  and dial  9  5 .
 - If it's a CO call, press   and dial  9  .
- You hear two beeps and your Record key flashes. The beeps periodically remind you that you are recording.

Volume Control

Your telephone has four separate adjustments: station ringing volume, handset receiver volume, station speaker volume, and LCD contrast on display phones.

Volume Control

To adjust the Ringing Volume:

1. Press ▼ **VOL** or **VOL** ▲ while the phone is ringing or idle.

To adjust the Handset Receiver Volume:

1. Press ▼ **VOL** or **VOL** ▲ while on a handset call.

To adjust the Speaker Volume:

1. Press ▼ **VOL** or **VOL** ▲ in handsfree mode.

To adjust the LCD contrast for display phones:

Do not lift handset.

1. Press ▼ **VOL** or **VOL** ▲ while the phone is idle.

Charts

This section contains handy charts for your reference. You'll find:

- The dialing plan (the numbers you dial) -- see below
- Flash rates for your telephone keys - see page 86

Your System's Dialing Plan			
With certain system programming changes, the feature access codes may be different than described. Enter your revised codes in the blank column to the right of the standard codes.			
	Portrait 308 Standard Code	Portrait 824 Standard Code	Your Revised Code
Extensions	10 - 17	10 - 33	
Operator Access	0	0	
Outside Lines	01 - 03	01 - 08	
Door Box Numbers	88 - 89	88 - 89	
Queue Groups	1 - 6	1 - 6	
Hunt Groups	0 - 4	0 - 4	
Internal Page Zones	80 - 84	80 - 84	
External Page Zones	85	85 - 87	
Speed Dial #'s: System	00 - 99 or 000-199	00-99 or 000-199	

Charts

System Flash Rates for LEDs

Your phone is idle (not on a call) All LEDs out (dark)

Outside Calls

An outside line is busy The line key is **ON (Red)**
An outside call is ringing your phone The line key flashes **Slowly (Red)**
And then you answer it The line key is **ON (Green)**
You place the outside call on Hold The line key flashes **Quickly (Green)**
Or a co-worker places the call on Hold The line key flashes **Moderately (Red)**
You place the outside call on Exclusive Hold The line key flickers **Moderately (Green)**
You place the outside call on Hold The line key flashes **Quickly (Green)**

Intercom Calls

An Intercom call rings your phone ICM flashes **Quickly (Red)**
You answer the Intercom call ICM is **ON (Red)**
You place the Intercom call on Hold ICM flickers **Slowly (Red)**
And then it recalls to you ICM flickers **Slowly (Red)**

Miscellaneous Features

You activate Microphone Mute MIC is **ON (Red)**
You activate Do Not Disturb DND/CONF is **ON (Red)** or flashes **Moderately (Red)** (depending on programming)
You send a Message Waiting MW flickers **Moderately (Red)**
You have a Message Waiting MW flashes **Quickly (Red)**
You activate Call Forwarding TRFR flashes **Slowly (Red)**
Your phone is Monitored MON flashes **Quickly (Red)**
You are Monitoring a phone MON flickers **Moderately (Red)**

A

Account Codes	.9
Alarm Clock	.9
Answering Outside Calls	.52
Automatic Line Access	.54

B

Background Music	.11
------------------	-----

C

Call Forwarding	.13
To Voice Mail	.82
Call Parking	.14
Call Timer	.14
Call Waiting	.15
Callback	.22
Calling a Co-Worker	.2
Camp-On	.15
Charts	.85
Conference	.23
SEE Meet-Me	
SEE ALSO Meet-Me	
Conference	
Conference, Unsupervised	.76
Confirmation Tone	.24

D

Date Setting	
SEE Time and Date Setting	
Dial Block	
SEE Toll Restriction	

Direct Line Selection

Console, DSS	.25
Direct Station Selection,	
Extension	.26
Directed Call Pickup	.28
Directory Dialing	.29
DLS Console	.25
DND	

 SEE Do Not Disturb

Do Not Disturb	.30
Door Box	.31
DP to DTMF Dialing	.54
DSS Console	.25
Dual Handsfree Hotline	.38

E

Executive Override	.32
Extension Hunting	.33
External Page	.58

F

Feature Keys	.59
Flash	.33
Forwarding	
To Voice Mail	.82

H

Handling and Rerouting	
Your Calls	.3
Handsfree	.34
Have a Telephone Meeting	.6
Headset Compatibility	.36

Index

Hold36
Hotline-Dual Handsfree Hotline .38

I

ICM
 SEE Intercom
If You Need Privacy5
Intercom39
Internal Page58

L

Last Number Redial40
Leaving a Voice Mail Message .81
Line Queuing53
LND
 SEE Last Number Redial

M

Mailbox Transfer82
Meet-Me Conference41
Message Storing
 SEE Name/Message Storing
Message Waiting43
Microphone Mute45
Monitor
 SEE Room Monitor

N

Name/Message Storing46
Night Answer49

O

Off-Hook Signaling50
Off-Hours Ringing
 SEE Night Answer
One-Touch Keys59
Outside Calls2
Outside Calls, Answering52
Outside Calls, Placing52
 Automatic Line Access ...54
 Dial Block56
 DP to DTMF Dialing54
 Line Queuing53
 PBX Compatibility55
 Private Line55
 Warning Tone56

P

Paging58
Park14
PBX Compatibility55
Personalizing Your Telephone ..7
Placing Calls Quickly4
Placing Outside Calls52
Private Line55
Programmable Keys59

R

Recording
 Voice Mail Record83
Repeat Dial62
Room Monitor62

S

- Save63
- Selectable Display Messaging .. .65
- Speakerphone34
- Speed Dial74
- Step Calling76
- Streamlining Your Telephone's
 Operation6

T

- Tandem Calls76
- Tandem Trunking
 SEE Tandem Calls
- Time and Date Setting78
- Timer14
- Transfer79
 - To Voice Mail82

U

- Unsupervised Conference76
- Using Your Telephone1

V

- Voice Mail80
 - Calling Your Mailbox81
 - Forwarding82
 - Leaving a Message81
 - Recording Your Call83
 - Tranferring to Voice Mail ..82
- Volume Control83

W

- Warning Tone56
- When You Work In Groups5
- When Your Call Can't Go
 Through3

Y

- Your Multibutton Phone8

Index

NEC

NEC America, Inc., Corporate Networks Group
4 Forest Parkway, Shelton, CT 06484
Tel: 800-365-1928 Fax: 203-926-5458
cng.nec.com

Other Important Telephone Numbers

Sales:203-926-5450
Customer Service:203-926-5444
Customer Service FAX:203-926-5454
Technical Service:203-925-8801
Discontinued Product Service:900-990-2541
Technical Training:203-926-5430
Emergency Technical Service (After Hours)203-929-7920
(Excludes discontinued products)	

NEC

NEC America Inc., Corporate Networks Group
4 Forest Parkway, Shelton, CT 06484
TEL: 203-926-5400 FAX: 203-929-0535
cng.nec.com

